

**Features**

- Split Gate Trench MOSFET technology
- Excellent package for heat dissipation
- High density cell design for low  $R_{DS(ON)}$

**Applications**

- DC-DC Converters
- Power management functions
- Synchronous-rectification applications

**Product Summary**

BVDSS	RDSON	ID
60V	11mΩ	60A

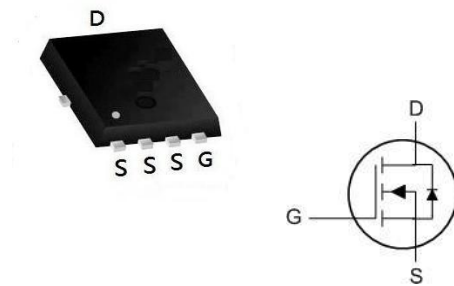
**PDFN5060-8L Pin Configuration**

**Absolute Maximum Ratings** ( $T_C=25^\circ\text{C}$  unless otherwise specified)

Symbol	Parameter	Max.	Units
$V_{DSS}$	Drain-Source Voltage	60	V
$V_{GSS}$	Gate-Source Voltage	$\pm 20$	V
$I_D$	Continuous Drain Current	$T_C = 25^\circ\text{C}$	60
		$T_C = 100^\circ\text{C}$	29
$I_{DM}$	Pulsed Drain Current <sup>note1</sup>	180	A
$E_{AS}$	Single Pulsed Avalanche Energy <sup>note2</sup>	36	mJ
$P_D$	Power Dissipation	$T_C = 25^\circ\text{C}$	60
$R_{\theta JC}$	Thermal Resistance, Junction to Case	2.5	$^\circ\text{C}/\text{W}$
$T_J, T_{STG}$	Operating and Storage Temperature Range	-55 to +175	$^\circ\text{C}$

**Electrical Characteristics** ( $T_J=25^\circ\text{C}$  unless otherwise specified)

Symbol	Parameter	Test Condition	Min.	Typ.	Max.	Units
<b>Off Characteristic</b>						
$V_{(BR)DSS}$	Drain-Source Breakdown Voltage	$V_{GS}=0V, I_D=250\mu A$	60	-	-	V
$I_{DSS}$	Zero Gate Voltage Drain Current	$V_{DS}=60V, V_{GS}=0V,$	-	-	1.0	$\mu A$
$I_{GSS}$	Gate to Body Leakage Current	$V_{DS}=0V, V_{GS}=\pm 20V$	-	-	$\pm 100$	nA
<b>On Characteristics</b>						
$V_{GS(th)}$	Gate Threshold Voltage	$V_{DS}=V_{GS}, I_D=250\mu A$	1.0	1.6	2.5	V
$R_{DS(on)}$	Static Drain-Source on-Resistance <small>note3</small>	$V_{GS}=10V, I_D=20A$	-	11	14	m $\Omega$
		$V_{GS}=4.5V, I_D=10A$	-	14	20	
<b>Dynamic Characteristics</b>						
$C_{iss}$	Input Capacitance	$V_{DS}=25V, V_{GS}=0V,$ $f=1.0MHz$	-	930	-	pF
$C_{oss}$	Output Capacitance		-	230	-	pF
$C_{rss}$	Reverse Transfer Capacitance		-	8	-	pF
$Q_g$	Total Gate Charge	$V_{DS}=30V, I_D=20A,$ $V_{GS}=10V$	-	22	-	nC
$Q_{gs}$	Gate-Source Charge		-	4.5	-	nC
$Q_{gd}$	Gate-Drain("Miller") Charge		-	3.5	-	nC
<b>Switching Characteristics</b>						
$t_{d(on)}$	Turn-on Delay Time	$V_{DD}=30V, I_D=20A,$ $R_G=1.6\Omega, V_{GS}=10V$	-	4.5	-	ns
$t_r$	Turn-on Rise Time		-	2.7	-	ns
$t_{d(off)}$	Turn-off Delay Time		-	13.8	-	ns
$t_f$	Turn-off Fall Time		-	2.7	-	ns
<b>Drain-Source Diode Characteristics and Maximum Ratings</b>						
$I_S$	Maximum Continuous Drain to Source Diode Forward Current		-	-	50	A
$I_{SM}$	Maximum Pulsed Drain to Source Diode Forward Current		-	-	180	A
$V_{SD}$	Drain to Source Diode Forward Voltage	$V_{GS}=0V, I_S=30A$	-	-	1.2	V
$t_{rr}$	Body Diode Reverse Recovery Time	$T_J=25^\circ\text{C},$ $I_F=20A, di/dt=100A/\mu s$	-	18	-	ns
$Q_{rr}$	Body Diode Reverse Recovery Charge		-	12	-	nC

Notes:1. Repetitive Rating: Pulse Width Limited by Maximum Junction Temperature

2. EAS condition:  $T_J=25^\circ\text{C}, V_{DD}=30V, V_G=10V, R_G=25\Omega, L=0.5mH, I_{AS}=12A$

3. Pulse Test: Pulse Width $\leq 300\mu s$ , Duty Cycle $\leq 0.5\%$

## Typical Performance Characteristics

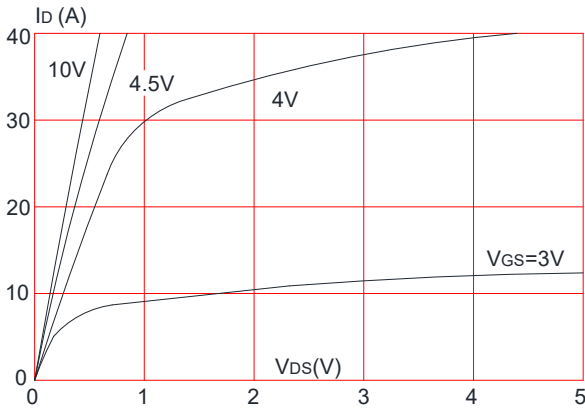
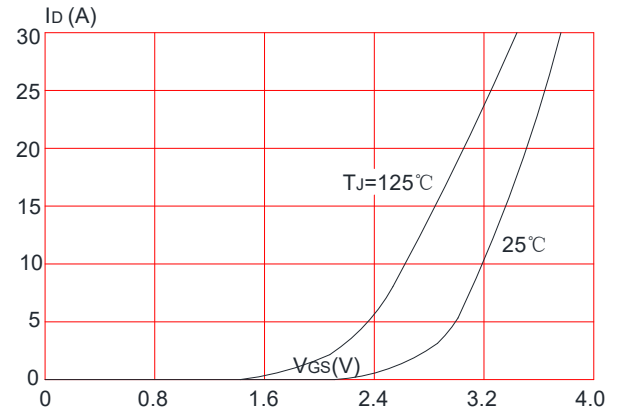
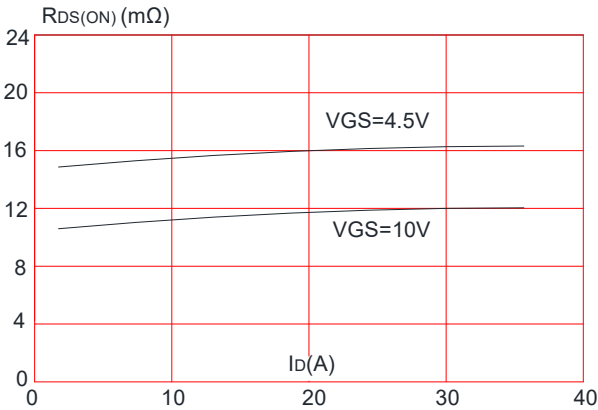
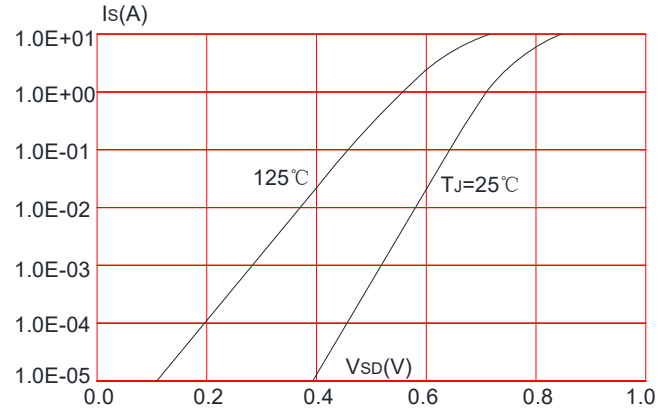
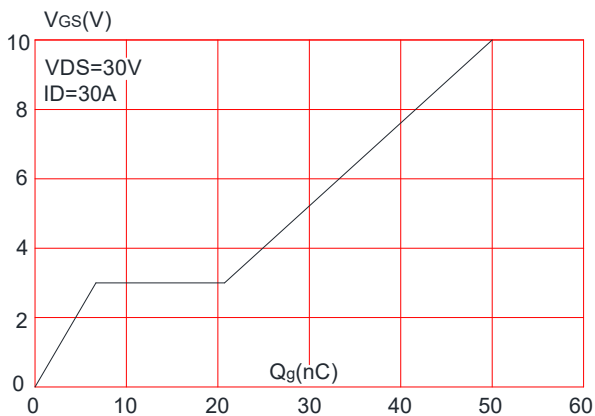
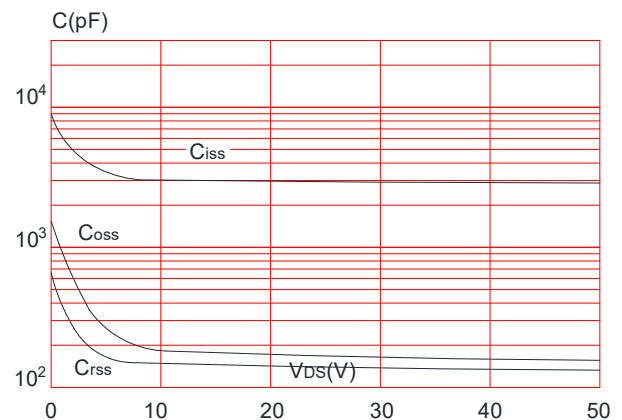
**Figure 1: Output Characteristics**

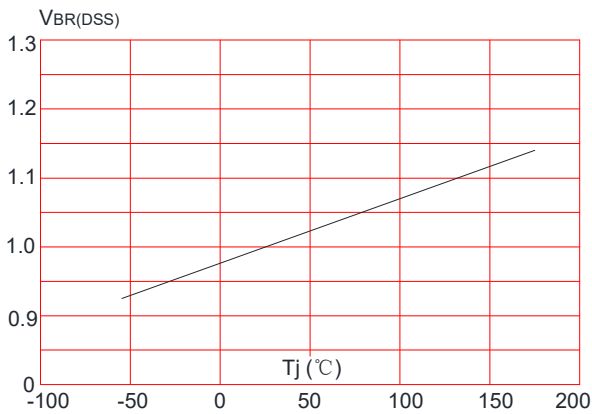
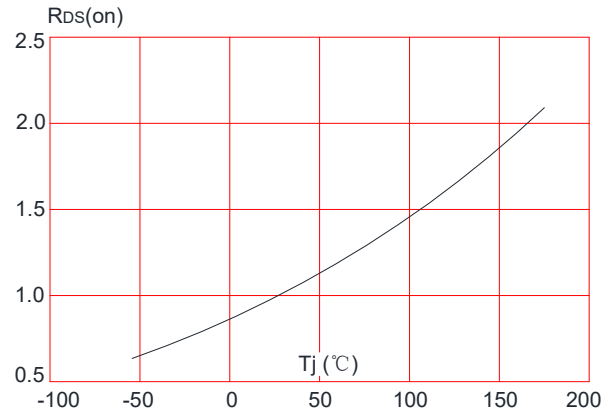
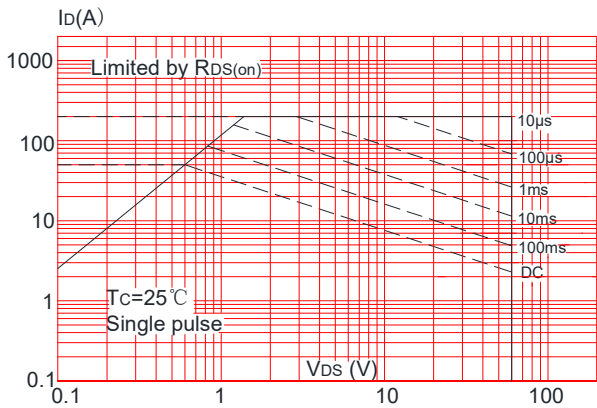
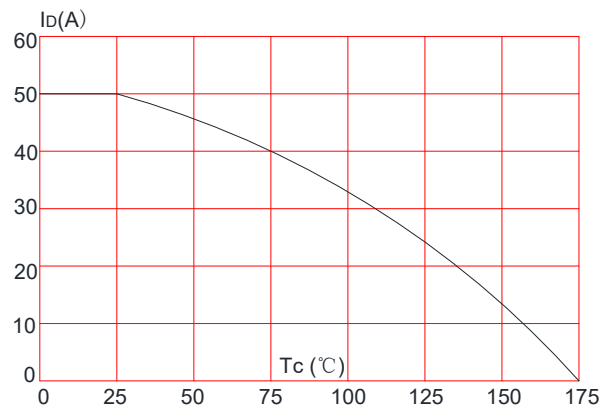
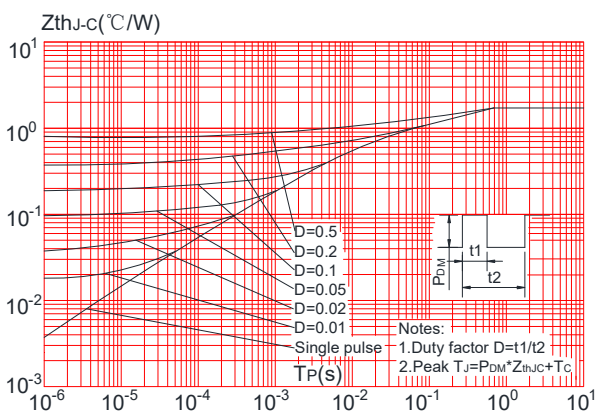
**Figure 2: Typical Transfer Characteristics**

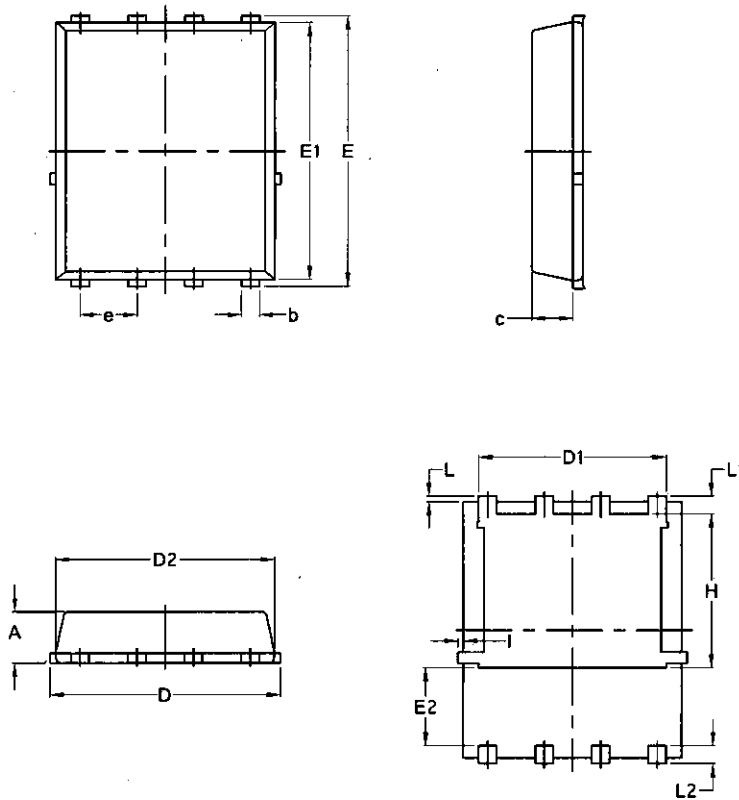
**Figure 3: On-resistance vs. Drain Current**

**Figure 4: Body Diode Characteristics**

**Figure 5: Gate Charge Characteristics**

**Figure 6: Capacitance Characteristics**

**Figure 7: Normalized Breakdown Voltage vs. Junction Temperature**

**Figure 8: Normalized on Resistance vs. Junction Temperature**

**Figure 9: Maximum Safe Operating Area**

**Figure 10: Maximum Continuous Drain Current vs. Case Temperature**

**Figure.11: Maximum Effective Transient Thermal Impedance, Junction-to-Case**

**Package Mechanical Data-PDFN5060-8L-Single**

Symbol	Common			
	mm		Inch	
	Mim	Max	Min	Max
A	1.03	1.17	0.0406	0.0461
b	0.34	0.48	0.0134	0.0189
c	0.824	0.0970	0.0324	0.082
D	4.80	5.40	0.1890	0.2126
D1	4.11	4.31	0.1618	0.1697
D2	4.80	5.00	0.1890	0.1969
E	5.95	6.15	0.2343	0.2421
E1	5.65	5.85	0.2224	0.2303
E2	1.60	/	0.0630	/
e	1.27 BSC		0.05 BSC	
L	0.05	0.25	0.0020	0.0098
L1	0.38	0.50	0.0150	0.0197
L2	0.38	0.50	0.0150	0.0197
H	3.30	3.50	0.1299	0.1378
I	/	0.18	/	0.0070